

**FIRST
EDITION**

Union Special[®]
INDUSTRIAL SEWING EQUIPMENT

CATALOG NO. T113L

STYLES

61100A

61100B

61100C

LIST OF PARTS

Catalog No. T113 L

LIST OF PARTS

Styles

61100 A

61100 B

61100 C

First Edition

Copyright 1957

by

Union Special Corporation
Rights Reserved in All Countries

Union Special
CORPORATION
INDUSTRIAL SEWING MACHINES
CHICAGO

February, 1974

Printed in U.S.A.

IDENTIFICATION OF MACHINE

Each Union Special carries a style number which is stamped in the name plate on the machine. Style numbers are classified as standard and special. Standard style numbers have one or more letters suffixed, but never contain the letter "Z". Example: "Style 61100 A". Special style numbers contain the letter "Z". When only minor changes are made in a standard machine, a "Z" is suffixed to the standard style number. Example: "61100 AZ".

Styles of machines similar in construction are grouped under a class number which differs from the style number in that it contains no letters. Example: "61100".

APPLICATION OF CATALOG

This catalog applies specifically to the standard styles of machines as listed herein. It can also be applied with discretion to some special machines in Class 61100. All references to direction, such as left and right, front and back, etc., are taken from the operator's position while seated at the machine. Operating direction of handwheel is toward the operator.

STYLES OF MACHINES IN CLASS 61100

61100 A Streamlined, Single Needle Basting Machine, Taupe Finish, Push Button Stitch Regulator, Visible Stitch Indicator, Automatic Lubrication of Lower Mechanism, for Light and Medium Weight Material, such as Basting Pockets, Pocket Welts, and Pocket Flaps. Stitch Type 101.

61100 B Same as 61100 A, except for Heavy Weight Material, such as Coats, Suits, Topcoats, Overcoats, Ladies' Coats and similar Garments. Stitch Type 101.

61100 C Same as 61100 A, except equipped with Tape Reel for Taping Hems on Skirts, Dresses, Ladies' Coats, etc. Seam Specification 101 L_{Sa}-1 (inverted).

NEEDLES

Each Union Special needle has both a type number and a size number. The type number denotes the kind of shank, point, length, groove, finish and other details. The size number, stamped on the needle shank, denotes the largest diameter of the blade measured in thousandths of an inch midway between the shank and the eye. Collectively, type number and size number represent the complete symbol.

Standard needle for Styles 61100 A and 61100 C is Type 113 GS. It is of extra short length, double groove, struck groove, spiral groove, ball eye, spotted, chromium plated, and is available in sizes 029, 032, 036, 040, 044, 049, 054.

Standard needle for Style 61100 B is Type 133 GS. It is of short length, double groove, struck groove, spiral groove, ball eye, spotted, chromium plated, and is available in sizes 032, 036, 040, 044, 049, 054.

To have needle orders promptly and accurately filled, the empty package, a sample needle, or type and size number should be given. See label on package. A complete order should read: "1000 Needles, Type 113 GS, Size 040".

Selection of proper needle size should be determined by size of thread used. Thread should pass freely through needle eye in order to produce a good stitch formation.

For best results, use only genuine Union Special needles in the operation of this machine. They are packaged under our brand name, *Union Special*, which is backed by a reputation for producing highest quality needles for more than three-quarters of a century.

IDENTIFYING PARTS

Where the construction permits, each part is stamped with its part number. On some smaller parts, and those where the construction does not permit, an identification letter is stamped to distinguish the part from similar ones.

All part numbers represent the same part, regardless of the catalog in which they appear.

TERMS

Prices are strictly net cash and subject to change without notice. All shipments are forwarded at the buyer's risk f. o. b. shipping point. Parcel Post shipments are insured unless otherwise directed. A charge is made to cover the postage and insurance.

LUBRICATION

CAUTION!

The oil has been drained from the looper drive eccentric and main reservoirs before shipment and these reservoirs must be filled before starting to operate. Lubricate machine thoroughly in accordance with instructions and run slowly for several minutes to distribute the oil to the various parts. Full speed operation can then be expected without damage.

RECOMMENDED OILS

Use a straight mineral oil of a Saybolt viscosity of 90 to 125 seconds at 100° Fahrenheit in both reservoirs. This is equivalent to Union Special oil specification No. 174.

Oils conforming to specification No. 83, may also be used in the manually oiled places.

With needle bar at top of its stroke, oil holes (A & B, Fig. 1) in top of machine twice daily. Both reservoirs are filled through oil cup "C" and the supply should be replenished if required. The oil level should be checked from time to time and kept between the lines on gauge "D".

In order to determine if the oil tube from the main reservoir to the looper drive eccentric reservoir is functioning, check the oil level by tilting machine back against the rest pin and remove screw "E" (Fig. 2).

CAUTION!

Do not use a compounded oil in the reservoirs as these oils separate and froth.

Lubrication of the mechanism below the bed plate is automatically accomplished through the feed driving shaft which is tubular. Oil is introduced into the shaft at the gear end by means of an oil distributing plate (A, Fig. 3) which is secured to the large gear case cover (B) by means of two screws (C) and retaining block (D).

Should it ever become necessary to remove any of the parts from the gear case, it is imperative that the adjustment of the oil distributing plate be checked very carefully. This can be done by removing the large plug screw at right end of the gear housing and looking through the hole. The low point of the oil distributing plate must be even with or slightly below the center of the shaft (E) and just touching it. This is a very important adjustment, as the functioning of the automatic lubrication of the lower part of the machine depends upon it.

The following is a numerical list of the parts used in this machine. Quantities, part numbers, and descriptions are given. Following the parts list are photographs of some of the major parts.

Amt.	Part No.	Description	Amt.	Part No.	Description	Amt.	Part No.	Description
1	G26	Screw for 61303 E	1	719	Set Screw for 61437 C	1	22845 D	Stud for 61434 (15037 A)
4	30-56 Blk.	Wood Plug for 61132	1	753	Tape Spool Support	1	22845 G	Screw for 61449 E
1	50-552 Blk.	Plug for 61132	2	6990	Axle Cone for 61100 C (22576)	1	22874 F	Screw for 61468 (9937)
1	50-558 Blk.	Plug for bed	1	8372 A	Spring for 61120 A	1	22880	Spot Screw for main shaft counterweight
1	50-568 Blk.	Oil Gauge	2	8372 A	Washer for 51758	1	22880	Spot Screw for 61449 E
2	HA61 D	Screw for intermediate gear shaft collar, right	1	9937	Washer for 61391 D	2	22884	Screw for main shaft gear
2	HA61 D	Screw for intermediate gear shaft collar, left	1	15037 A	Nut for 22874 F	2	22884	Screw for feed drive shaft gear
1	77	Screw for presser bar guide	1	15872 F	Nut for 22845 D	2	22884	Screw for feed drive shaft collar
2	88	Screw for looper shaft collar	2	21114	Spring for foot lifter lever	2	22884	Screw for 61466 A
1	88	Screw for 161	1	21114 W	Spring for 61120 A	1	22890	Screw for 61267
1	88 C	Screw for 61438 C	1	21171 R	Washer for 51758	1	22892	Screw for 61367
1	88 D	Screw for feed dog holder support	1	21171 S	Washer for 61391 D	1	22892	Screw for presser bar connection
1	89	Screw for feed bar	1	21171 U	Nut for 22845 D	2	22894 C	Screw for looper holder
2	90	Screw for 61141 G	1	21171 V	Spring for 61100 C (22581)	2	22894 E	Screw for 61236 G
2	90	Screw for 61336 Y	1	21171 W	Tape Tension Guide for 61100 C (22858 C)	2	22894 V	Screw for main shaft counterweight
1	91	Looper Set Screw	1	21171 V	Tape Tension Guide Bracket for 61100 C (22585 A)	1	29126 BV	Looper Drive Eccentric Assembly for 61100 A, 61100 C
2	91 A	Screw for 61173	1	21171 W	Tape Guide Wire for 61100 C (22585 A)	1	29126 CN	Looper Drive Eccentric Assembly for 61100 B
1	93 A	Screw for presser bar guide	1	21177 A	Tape Reel Tension Spring for 61100 C	1	29126 DU	Feed Drive Eccentric Assembly
1	93 A	Screw for 61246 A	1	22528	Screw for 61439	1	29475 K	Bed Slide Assembly
1	95	Screw for stitch length indicator	1	22539 D	Plug Screw for base	1	39151	Needle Clamp Nut
1	96	Spot Screw for stitch length indicator	1	22562 A	Screw for needle bar connection stud	1	41064 B	Looper Drive Shaft
1	96	Spot Screw for 61237	3	22564 B	Screw for timing collar 61437 A	1	43217	Needle Bar
1	96	Spot Screw for 61137 B	2	22569 B	Screw for head cover	1	51236 A	Hinge Pin for 61285 G (22768)
1	96 A	Screw for 61141	1	22570 A	Screw for 51758	1	51242 M	Washer for 22802 A
1	98	Set Screw for 61237	1	22570 A	Screw for 61282 A	1	51292 A	Tension Post Ferrule
1	98	Set Screw for 61137 B	1	22570 A	Screw for 61382 J	1	51292 D	Tension Thread Eyelet
1	107	Tension Post Ferrule	1	22570 B	Screw for 61394 Q	1	51430 F	Nut for 22840 A on 61120 C
1	108	Tension Post Nut	3	22574	Screw for main shaft counterweight	1	51491 C	Thread Guide
2	109	Tension Disc	1	22576	Screw for 61321 J	1	51758	Frame Needle Thread Eyelet (8372 A, 22570 A)
1	110-0	Tension Spring	1	22576	Screw for 753	1	51930	Spring for 61120
1	161	Collar for 61445	2	22581	Screw for 21171 S	2	52782 C	Stud Screw for head cover on 61100 C
2	258 A	Nut for 21114 W, on 61100 C	1	22585	Screw for 21171 S	1	61102	Bed Slide
2	376	Screw for throat plate	1	22585 A	Screw for 61151	1	61105	Feed Dog (22768)
4	531	Screw for stitch regulating shaft collar	1	22585 A	Screw for 21171 V, 21171 W	1	61108 A	Looper, marked "CV" (91)
1	652 B-20	Lock Washer for lifter lever stud	1	22597 A	Screw for 21171 U	1	61120	Presser Foot for 61100 A (22775)
1	660-142	Spring Cotter Pin for 61368 A	1	22597 A	Adjusting Screw for 61391 D	1	61120 A	Presser Foot for 61100 B (22775)
2	660-184	Oil Tube Sleeve for 61193	1	22647 K-24	Screw for 61445	1	61120 C	Presser Foot for 61100 C (22775)
2	660-190	Oil Tube Coupling Nut for 61193	1	22712 F	Screw for 62262	1	61124-068	Throat Plate (376)
1	660-257	Gasket for 22730	1	22730	Thumb Screw for 21177 A	1	61130	Shank for presser foot 61120
2	666-20	Oil Wick for oil tubes 61293, 61393 B	1	22743	Screw for 61368 F	1	61130	Shank for presser foot 61120 A
1	666-104	Oil Wick for main shaft bushing housing	1	22757 C	Plug Screw for 61282 A (660-257)	1	61130 A	Bottom for 61120
2	668-25	Steel Insert for tension thread eyelet	1	22758 B	Plug Screw for 61132	1	61130 B	Bottom, right, for 61120 A (22799 U)
2	668-29	Locking Ring for 668-25	1	22758 B	Screw for 61255 H	1	61130 C	Bottom, left, for 61120 A (22799 U)
			1	22758 B	Screw for 61267	1	61130 D	Plunger, right, for 61120 A
			2	22768	Screw for 61367	1	61130 E	Plunger, left, for 61120 A
			1	22768	Screw for feed dog	1	61130 F	Equalizer, for 61120 A (22799 N)
			1	22775	Screw for 51236 A			
			1	22775	Screw for presser foot			
			1	22775 A	Screw for presser foot			
			1	22775 A	Screw for feed dog holder support			
			1	22799 M	Hand Lifter Screw Pin			
			1	22799 N	Screw for 61130 F			
			2	22799 U	Hinge Screw for presser foot 61120 A			
			1	22802 A	Screw for 61449 F			
			1	22817 A	Stud for 61468			
			1	22840 A	Adjusting Screw for presser foot 61120 C			

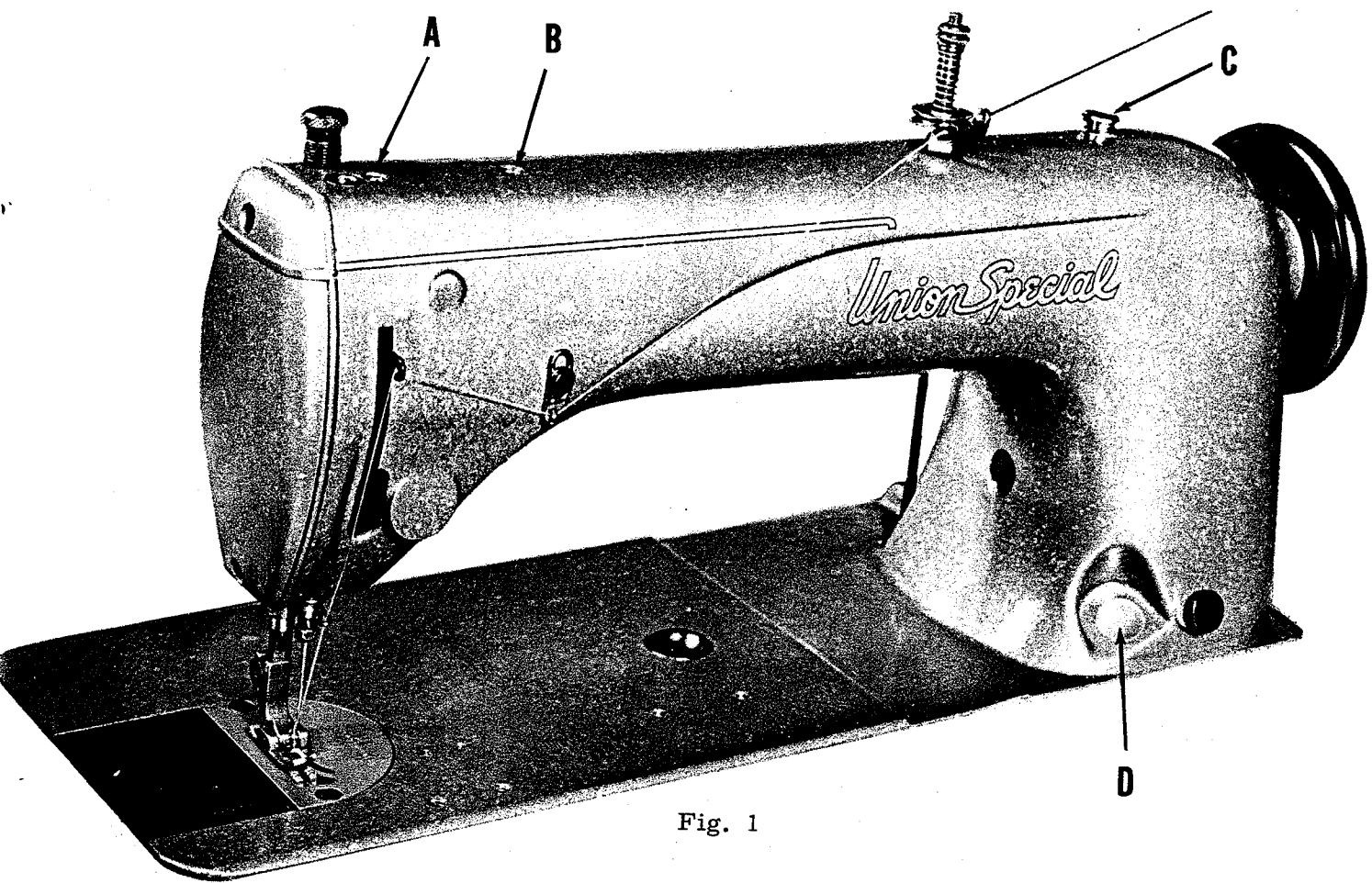

Fig. 1

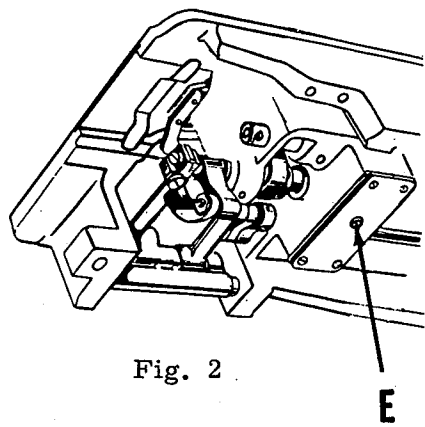

Fig. 2

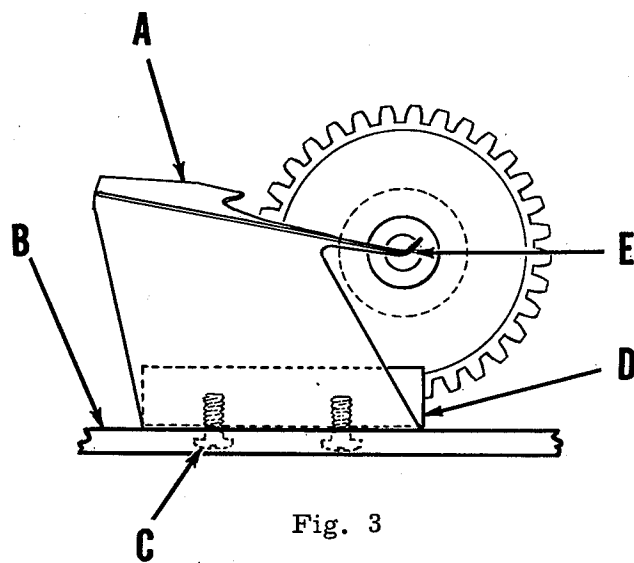
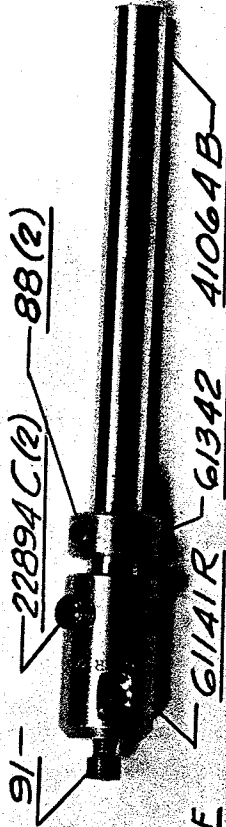

Fig. 3

Amt.	Part No.	Description	Amt.	Part No.	Description	Amt.	Part No.	Description
1	61130 G	Bottom for 61120 C	1	61263	Bushing for feed	1	61394 P	Housing Cover Oil
1	61132	Feed Driving Shaft			driving shaft			Distributing Plate
		(22743)			intermediate gear	1	61394 Q	Oil Distributing Plate
1	61132 C	Feed Driving Shaft	1	61264	Intermediate Gear			Retaining Block
		Oil Retaining			Shaft Collar, right			(22570 A)
		Bushing, left			(HA61 D)	1	61394 R	Gasket for 61394 Q
1	61137	Feed Driving	1	61264 A	Intermediate Gear	1	61394 AE	Oil Cup for filling
		Eccentric			Shaft Collar, left			main reservoir
1	61137 B	Looper Driving			(HA61 D)	1	61421	Handwheel Assembly
		Eccentric for	1	61265	Hand Lifter (22799 M)			for round or No. 1
		61100 B (96, 98)	1	61267	Lifter Lever Link for			"V" belt
1	61141	Looper Shaft Bushing			61100 A, 61100 C	1	61421 A	Pulley Hub
		(96 A)			(22758 B, 22892)	1	61432 B	Feed Driving Shaft
1	61141 G	Looper Drive Link (90)	1	61267 G	Spring Pin for 15872 F			Bushing, right
1	61141 R	Looper Holder (91,	1	61282 A	Housing Cover, left	1	61432 C	Feed Driving Shaft
		22894 C)			(22570 A, 22730)			Bushing, left
1	61149	Stitch Length Indica-	1	61282 D	Gasket for 61382 J	1	61432 D	Feed Driving Shaft
		tor for 61100 B	1	61282 E	Gasket for 61282 A			Oil Retaining
		(95, 96)	1	61285 G	Looper Driving			Bushing, right
1	61149 A	Stitch Length Indica-			Eccentric Strap			
		tor for 61100 A,	1	61293	Oil Tube for needle	1	61434 G	Washer for 63434 C
		61100 C (95, 96)			bar driving link	1	61437 A	Stitch Regulating
1	61149 G	Stitch Regulating	2	61293 N	Plug for inside of			Eccentric Timing
		Eccentric			arm			Collar (22564 B)
1	61149 H	Friction Disc for	1	61293 U	Oil Tube Coupling	1	61437 B	Stitch Regulating
		stitch regulating			Plug			Eccentric Pivot
		eccentric	1	61303 E	Edge Guide for	1	61437 C	Pin
1	61151	Take-up Eyelet	1	61321 J	61100 A, 61100 B(G26)	1	61437 C	Stitch Regulating
		(22585)			Handwheel for 61421			Eccentric Housing
1	61152	Crank Pin for	1	61321 L	(22574)	1	61438 C	(719)
		61100 B	1	61322 B	Washer for handwheel	1	61438 C	Feed Driving Eccen-
1	61154	Needle Bar Bushing,	1	61330	Main Shaft			tric Connecting Rod
		lower	1	61330 B-	Shank for 61120			(88)
1	61158	Presser Bar Connec-	1	31	Hinge Pin for presser	1	61439	Feed Dog Holder
		tion for 61100 B			foot 61120 C	1	61439 A	(22528)
		(22892)						Feed Dog Holder
1	61170	Needle Thread Guide	1	61330 B-	Hinge Pin for 61120	1	61439 A	Support (88 D,
1	61173	Bed Slide Spring	1	35	Shank for 61120 C			22775 A)
		(91 A)	1	61330 AH	Feed Rocker Shaft	1	61445	Stitch Regulating
2	61175	Machine Hinge Stud	2	61336 U	Bushing			Plunger (22597 A)
1	61193	Oil Tube for feed	1	61336 Y	Feed Rocker Oil	1	61447	Stitch Regulating
		driving eccentric			Wick (90)			Plunger Lever
		assembly	2	61342	Looper Shaft Collar			Spring
2	61193 A	Oil Tube Coupling	2	61342	(88)	1	61449 B	Spring for 61149 G
1	61233 N	Feed Lifter Link	1	61348 A	Stitch Regulating	1	61449 E	Stitch Regulating
					Shaft			Pawl Collar
1	61236	Feed Rocker			Needle Bearing Roller	1	61449 F	(22845 G, 22880)
1	61236 G	Feed Rocker Shaft	19	61351 K	Presser Spring			Stitch Regulating
		(22894 E)	1	61356	Main Shaft Driving			Pawl (22802 A,
1	61237	Looper Driving	1	61360	Gear (22884)			51242 M)
		Eccentric for	1	61360 G	Feed Driving Shaft	1	61449 H	Stitch Length Indica-
		61100 A, 61100 C			Collar (22884)			tor Insert
		(96, 98)	1	61366 C	Lifter Lever Exten-	1	61457	Presser Bar
1	61245 G	Stitch Regulating	1	61366 C	sion Stud (652 B-20)	1	61457 B	Presser Spring
		Plunger Binding			Lifter Lever Link for			Regulator
		Insert	1	61367	61100 B (22758 B,	1	61457 C	Presser Bar Bushing,
1	61246 A	Stitch Regulating			22892)			lower
		Plunger Lever (93 A)	1	61368	Lifter Lever Connec-	1	61458	Presser Bar Connec-
2	61248 H	Stitch Regulating			ting Rod			tion for 61100 A,
		Shaft Collar (531)	1	61368 A	Lifter Lever Connec-	1	61459 A	61100 C (22892)
1	61252 J	Crank Pin for	1	61368 A	ting Rod, complete			(77, 93 A)
		61100 A, 61100 C			(660-142)	1	61466 A	Foot Lifter Lever
1	61254	Needle Bar Bushing,	1	61368 F	Foot Lifter Ball Crank	1	61466 A	(22890)
		upper			Roller (22712 F)			Lifter Lever Bell
1	61255	Needle Bar Connec-	1	61382 J	Housing Cover, right	1	61468	Crank (22817 A,
		ting Stud (22562 A)			(22570 A)			22874 F)
1	61255 H	Needle Bar Link	1	B61382 H	Head Cover (22569 B)	1	61490	Main Shaft Bushing,
		(22757 C)			Main Shaft Counter-			right
1	61256 G	Presser Spring	1	61391 D	weight (22570 B,	1	61490 A	Main Shaft Bush., left
		Washer			22596 D, 22880,	1	62262	Intermediate Gear
1	61260 A	Feed Driving Shaft			22894 V)			Shaft (22597 A)
		Gear (22884)	1	61393 B	Oil Tube for left	1	63434 C	Feed Bar (22845 D)
1	61261 A	Feed Driving Shaft			main bearing	2	63435 A	Feed Bar Shaft
		Intermediate Gear				1	81292	Tension Post

NOTE: Numbers in parenthesis following parts' description indicate the screws, nuts, etc. used to attach or hold these parts.

91- 22894 C (2) 88 (2)



61141R 61342 41064B

51430F 22840R

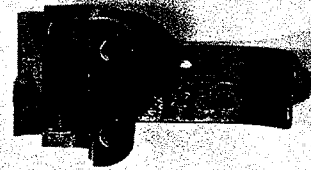

61120C

61120

61120A



61108A

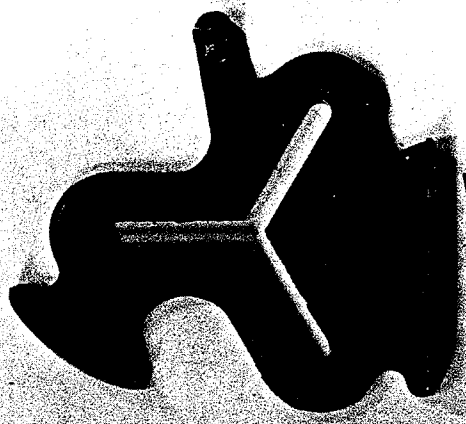

61303E



626

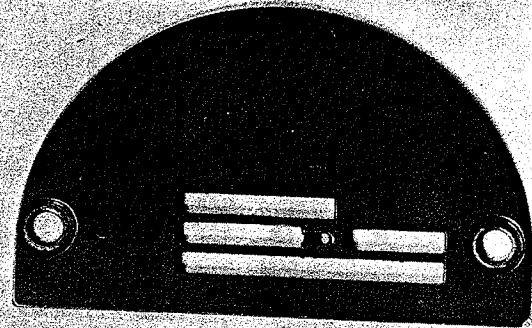

61124-068



376 (2)

22768 (2)

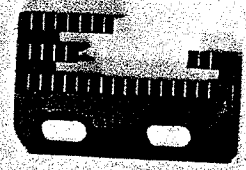

61105





61439

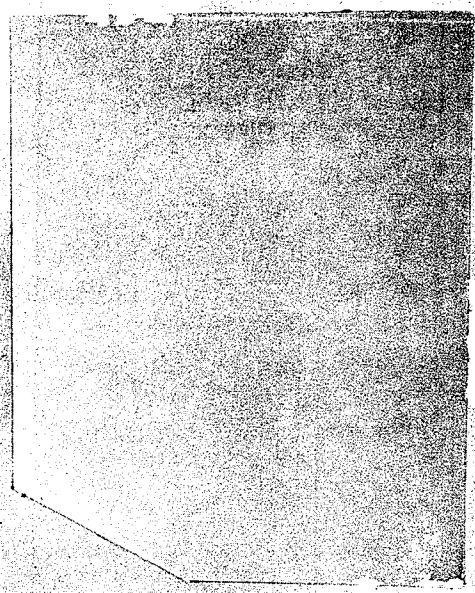

22528

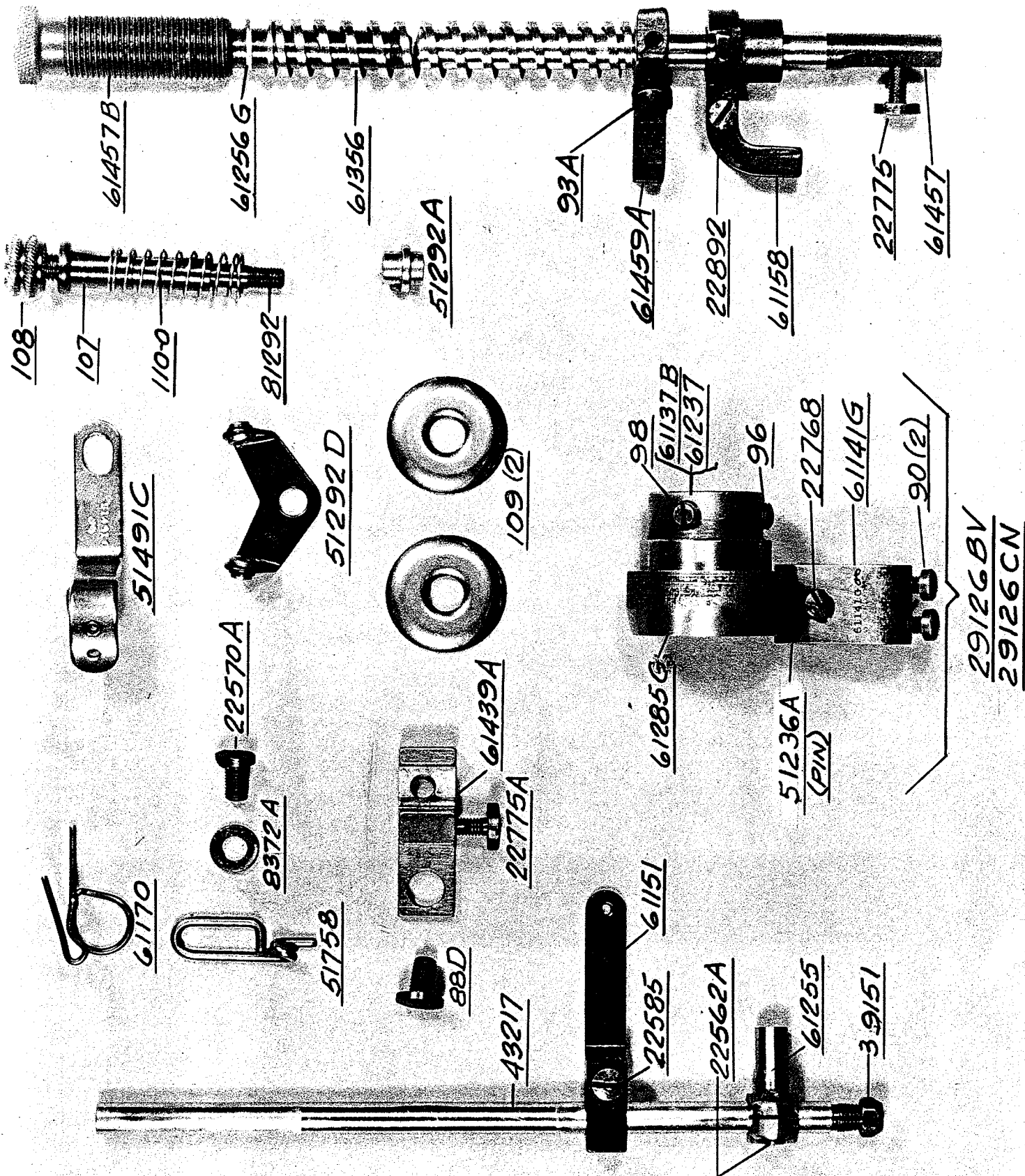



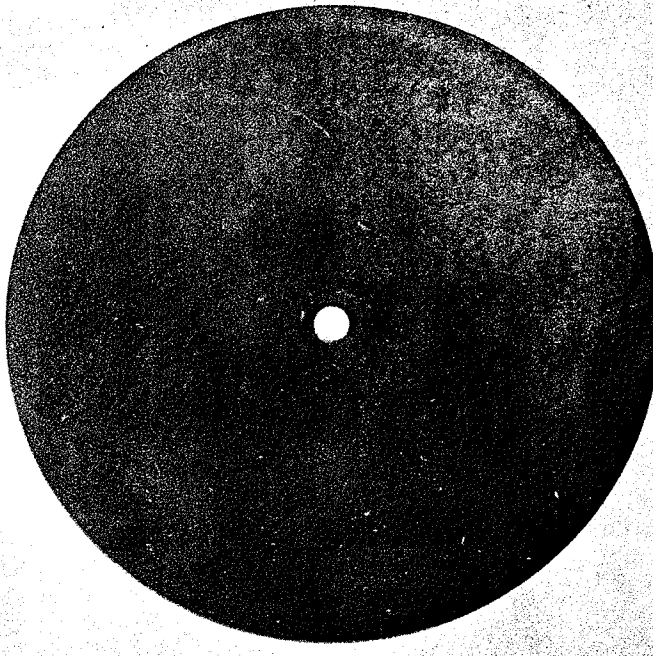

22576

753

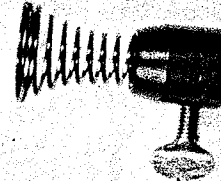
21114W

21114 (2)

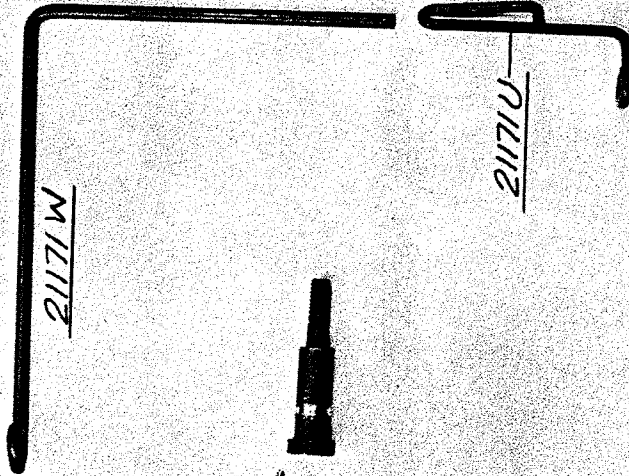
22647K-24

21177A



21171W

21171U



21171V

22585C

258A (2)



21171S



22585A (2)

22581 (2)

52782 C (2)

21171R

22570A (2)

61394Q

61394R

61394P

22539D

22570A (6)

22570A (4)

22730

61282A

61282E

91A(2)

61173

61382J

29475K

61282D

61102

B61382H

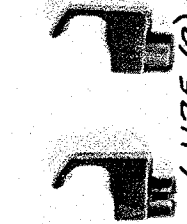
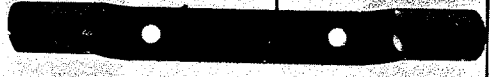
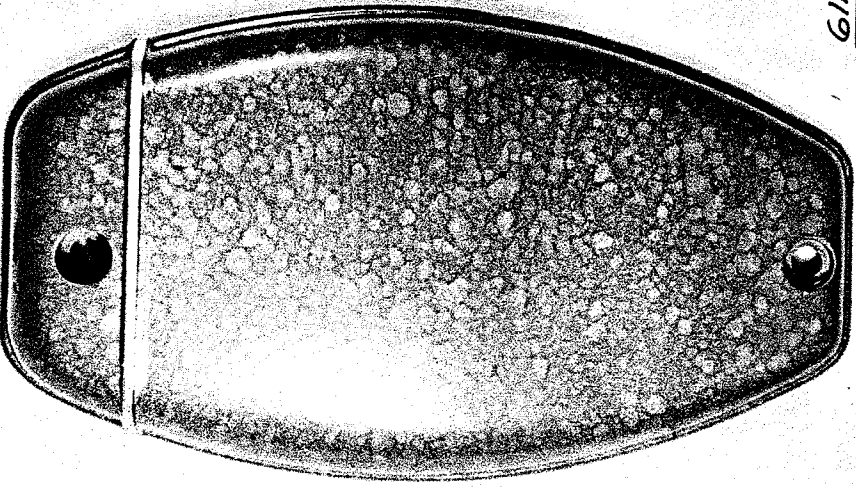
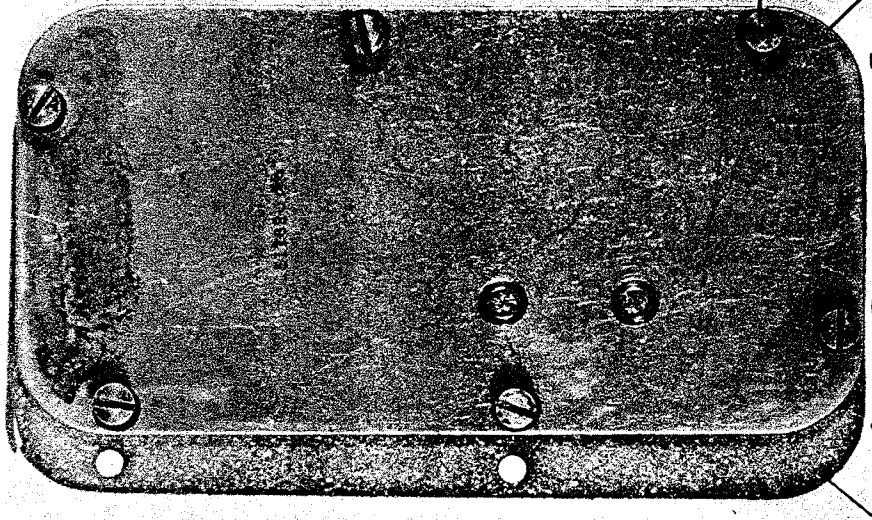

61175 (2)



22569B (2)



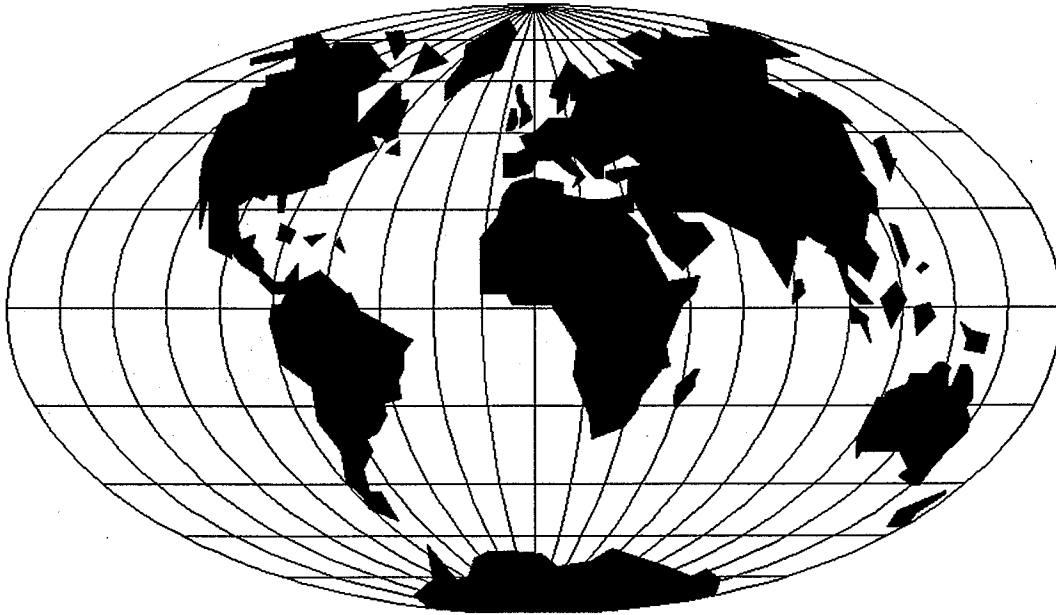

WORLDWIDE SALES AND SERVICE

Union Special Corporation maintains sales and service facilities throughout the world. These offices will aid you in the selection of the right sewing equipment for your particular operation. Union Special Corporation representatives and service technicians are factory trained and are able to serve your needs promptly and efficiently. Whatever your location, there is a qualified representative to serve you.

Corporate Office:
One Union Special Plaza
Huntley, IL 60142
Phone: 847•669•5101
Fax: 847•669•4454

European Distribution Center:
Union Special GmbH
Raiffeisenstrasse 3
D-71696 Möglingen, Germany
Tel: 49•07141•247•0
Fax: 49•7141•247•100

Brussels, Belgium
Charlotte, N.C.
El Paso, TX
Hong Kong, China
Huntley, IL
Leicester, England
Lille, France
Miami, FL
Milan, Italy
Möglingen, Germany
Montreal, Quebec
Osaka, Japan
Santa Fe Springs, CA

Other Representatives throughout all parts of the world.



Union Special
INDUSTRIAL SEWING EQUIPMENT